

Merrill FOH Plot

House Light Channels: 499 - 510

Chandeliers: Channels 461 - 466

RGBW - DMX addresses start at 475

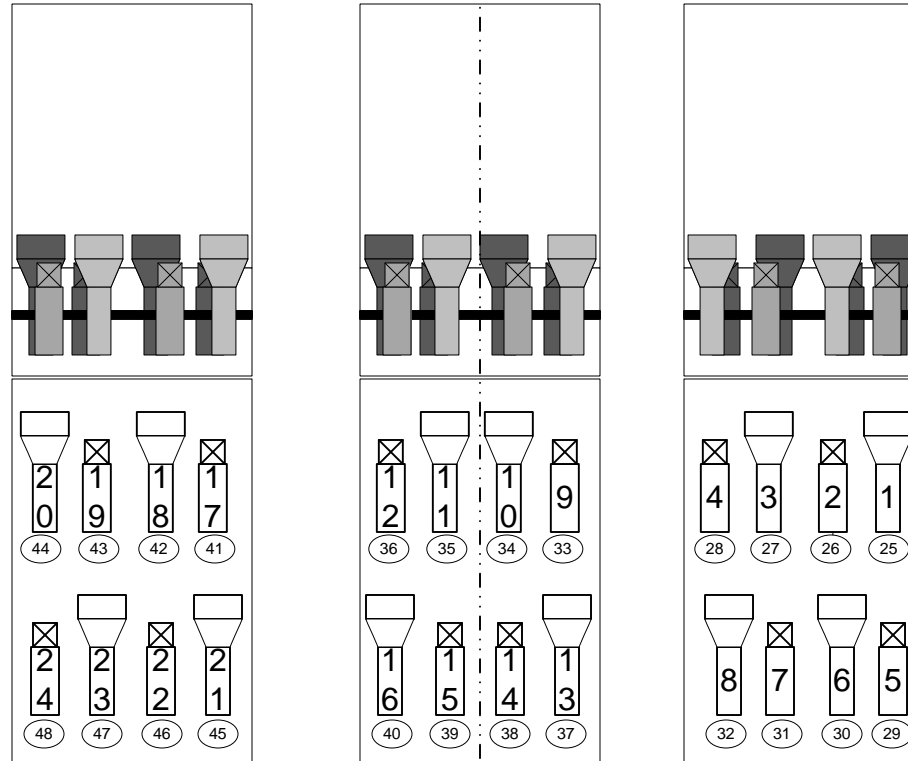
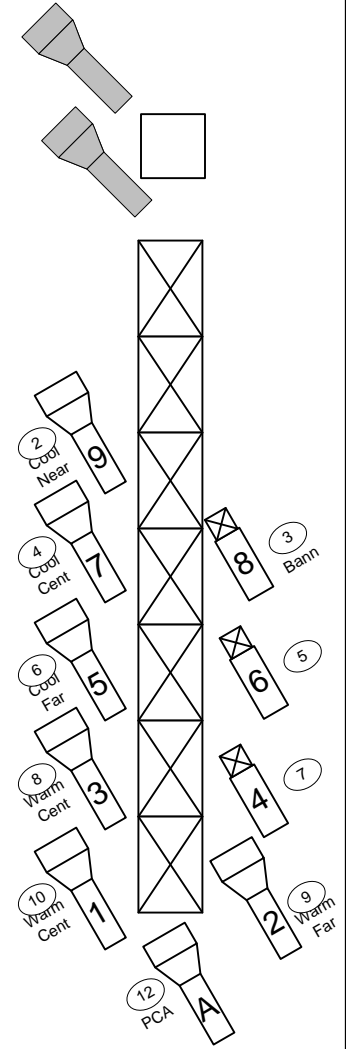
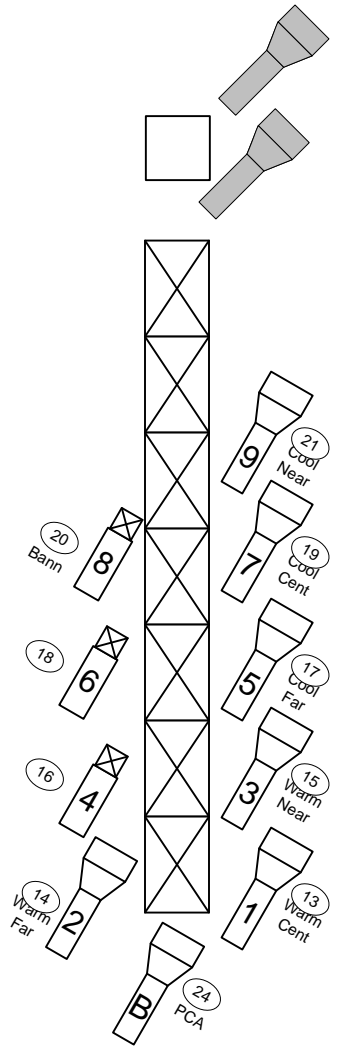

TOP

BOTTOM

1 19° ETC Source 4 @ 575w
 8 5.75" x 5.75" color frame

2 10° ETC Source 4 @ 575w
 4 12" x 12" color frame

Unit # 0
 Dimmer 00
 Purpose Wash

Merrill Overstage Rep Plot

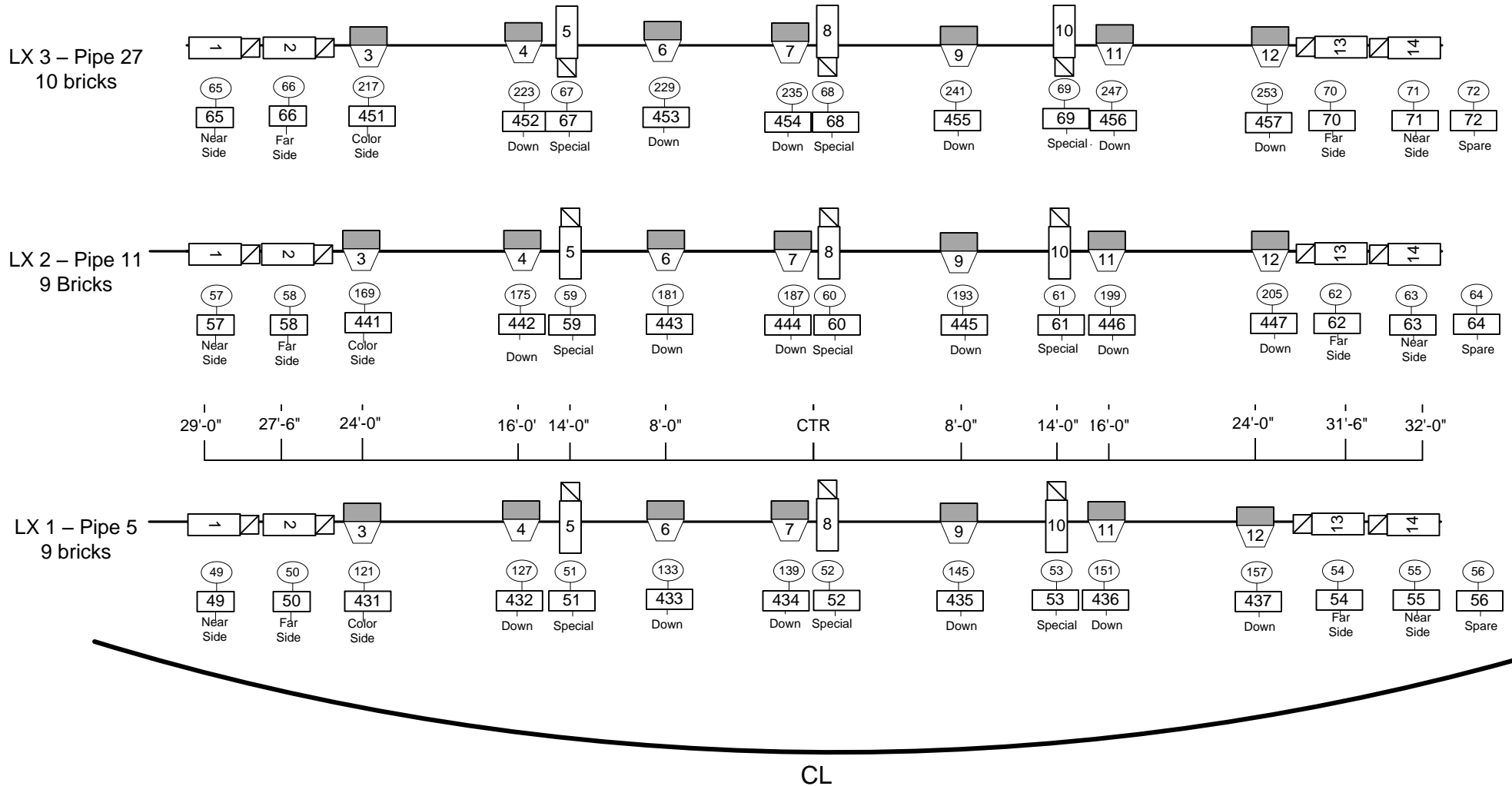

House Light Channels: 499 - 510

House Chandelier Addresses

Channel:	DMX:
461	475-478
462	479-482
463	483-486
464	487-490
465	491-494
466	495-498

Rep Plot cables setup in a bundle. Any moves require additional cable that is not provided.

Each Electric has 1 Spare dimmer, 1 spare 20 amp circuit and 1 spare DMX on universe 2.

Universe 1 (house DMX) has 48 addresses free - 73-120.

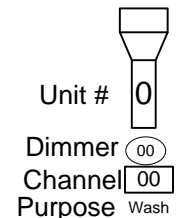
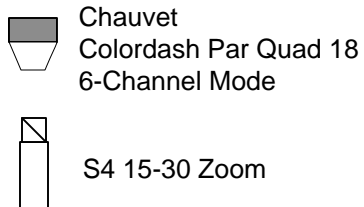

Merrill Ceiling Plot

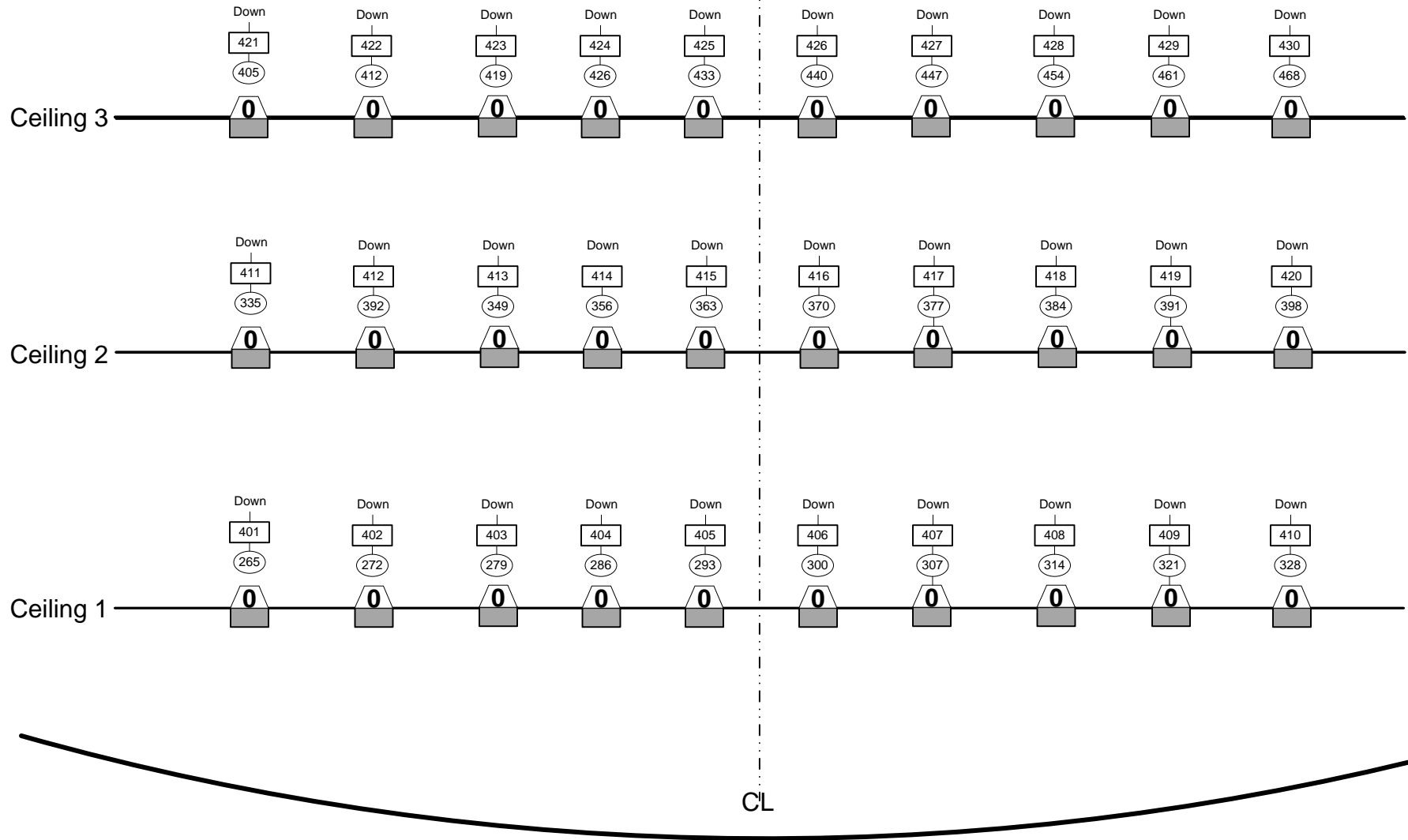

000 ION Patch Channel

000 DMX Start Channel

0 ETC Selador Desire 60 Studio

House Light Channels: 499 - 510

Chandeliers: Channels 461 – 466
RGBW - DMX addresses start at 475

Programming Note: Selador Settings

DMX Menu:
 Profile – HSIC; Strobe – off;
 Date Loss – HLL-4ever; Plus Seven – off;
 Fan Mode – Auto

LED Menu:
 Output – Regulated; Curve – Linear; Freq - 1200